

ELEKTRA BECKUM

Operating Instructions Planer/Thicknesser HC 260

Serial-No. 11.004 M

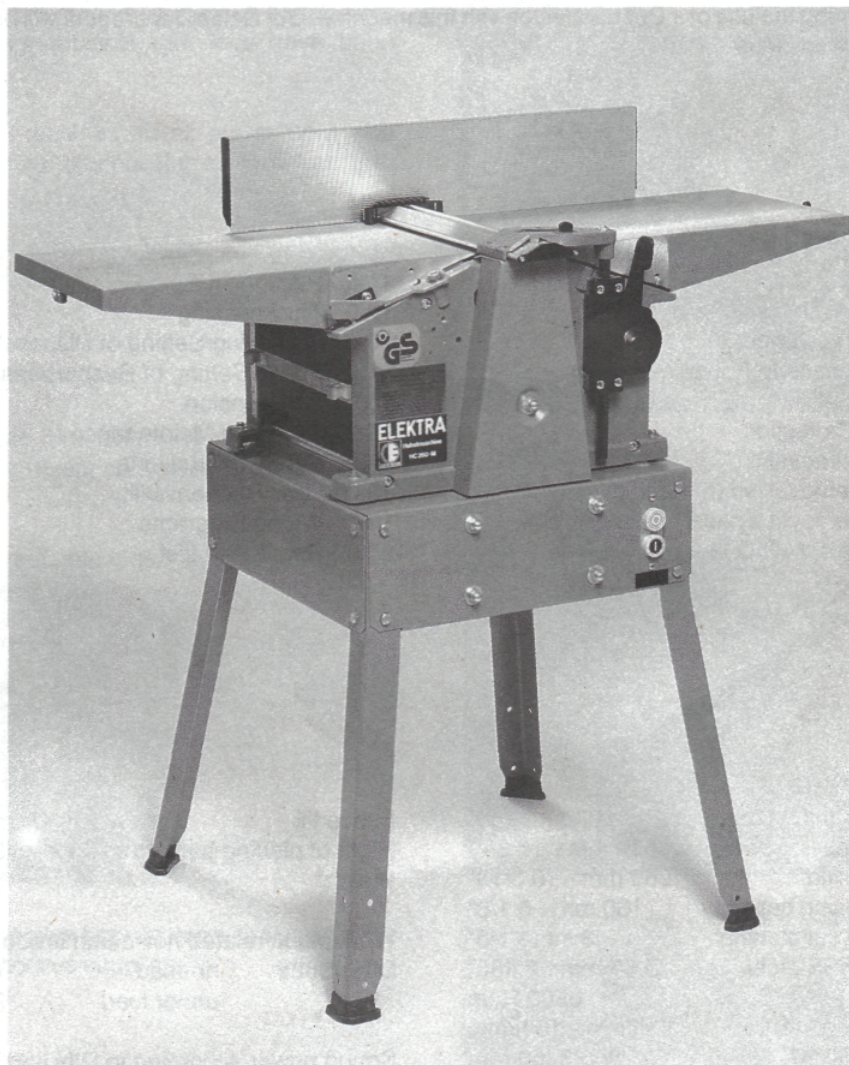

Attention!

Before taking your machine into operation
please read the operating instructions carefully and adhere to strictly.

Elektra Beckum reserves the right to discontinue models, accessories or options at any time or change specifications and materials, equipment and design without notice and without incurring obligation of any kind. Equipment referred to as available or optional may be at extra cost.

02/95 - GB

Art.-Nr. 115 104 71

U.K. Supplement to Operating Instructions for Elektra Beckum HC 260 M Combination Surfacing and Thicknessing Machine

Please note the following supplementary information associated with this machine:

U.K. Legislation and Codes of Practice

When used industrially within the U.K. this machine falls under the scope of

- Woodworking Machines Regulations 1974 and
- Use and Provision of Work Equipment Regulations 1992.

We strongly advise you to study and follows theses regulations.

Section 4.0 Connection to Power Mains

230 V motor. Although the motors supplied with this machine will run safely on a 13A domestic ring main. On starting the machine a high current of very short duration is drawn, which will blow your 13A fuse. This machine can only be connected to a 16A separate radial circuit using BS 4343 (CEE 17) plug and socket. Ensure the installation is protected by a suitably sized fuse or miniature circuit breaker.

This work should be undertaken only by a qualified electrician!

DUST COLLECTION

We strongly recommend the use of a Dust Collector with this machine. Our Sales Department will be happy to offer you advice on the correct collector.

Contents

1.0 Technical Data	11.0 Planing
2.0 Final Assembly	12.0 Thicknessing
3.0 Setting of Fence	13.0 Replacing/Setting of Disposable Blades
4.0 Connections to Power Mains	14.0 Fitting/Setting of Resharpenable Blades
5.0 Switch	15.0 Belt Tension
6.0 Motor Protection	16.0 Care and Maintenance
7.0 Chip Removal	17.0 Safety Instructions
8.0 Chip Removal when Planing	18.0 User Responsibility
9.0 Chip Removal when Thicknessing	19.0 Wiring Diagrams
10.0 Setting of VARIO Guard	20.0 Spare Part List

1.0 Technical Data

Over length planing tables	1000 mm - 40"	Fence tilt	max. 45°
Length thicknessing bed	400 mm - 15 3/4"	Height of planing beds from floor	860 mm - 34"
Max. working width	260 mm - 10 3/16"	Weight	ca. 60 kg - 132 lbs
Max. thicknessing capacity	160 mm - 6 1/8"		
Max. depth of cut planing	3 mm - 1/8"	Work place related noiseemmission according to	
Cutter block HSS steel	Ø 63 mm - 2.480"	DIN 45635	no-load 75.7 dB (A)
Cutter block speed	6500 Upm		under load 90.3 dB (A)
Thicknesser feed rate	5 m/min - 16 ft/min	Sound power according to DIN 45635	
Motor speed 50/60 Hz	2800/3360 rpm		no-load 92.2 dB (A)
			under load 95.4 dB (A)

Motors	1.8 kW/2.45 hp	230 V	50 Hz	single phase
	2.2 kW/3.00 hp	220-240 V	50/60 Hz	single phase
	2.2 kW/3.00 hp	110 V	50/60 Hz	single phase
	3.1 kW/4.20 hp	220-240 V	50/60 Hz	single phase
	2.8 kW/3.80 hp	380/415 V	50/60 Hz	three phase
	4.2 kW/5.70 hp	380/415 V	50/60 Hz	three phase
	4.2 kW/5.70 hp	220 V	50/60 Hz	three phase

Optional Accessories

	Stock-No.
Drilling/Morticing Attachment	091 100 3791
Cam-lock Clamp	091 100 9811
Workstand HC - E/ES	091 100 3775
Rollerstand RS 300	091 101 2367
Lock Bar Conversion Kit	091 100 1020
HSS Planer Blade	091 100 1047
Flexible Shaft 0-8 mm chuck	091 100 1004
Waxilit anti-seizing paste 70 gr tin	091 100 1071
Drill Chuck 0-10 mm UNF 1/2-20	091 100 3805
Rustic Planer Blade HSS	091 100 5603
Wheel Set/Workstand HCK	091 100 7100
Carrying Handle HC	091 100 9048
Wheel Set HCM	091 100 3783

2.0 Final Assembly

- 2.1 On single phase machines remove switch from motor housing, replace after legs have been installed.
- 2.2 On 3-phase machines install power cord with strain reliever to motor housing as shown at right.

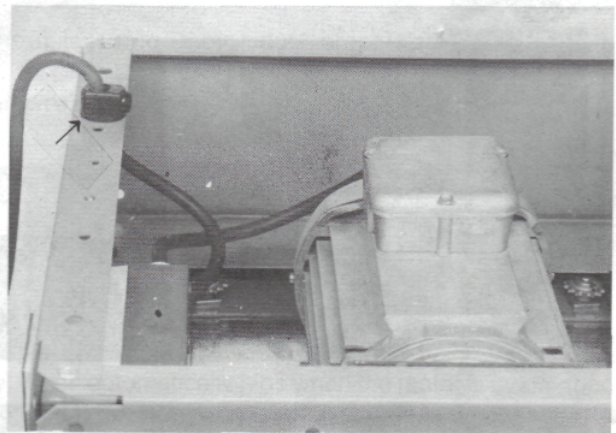

- 2.3 Place legs into motor housing and secure with hex. bolts M8x16, spring washer B8 and hex. nut M8.

- 2.4 Push rubber feet onto legs.

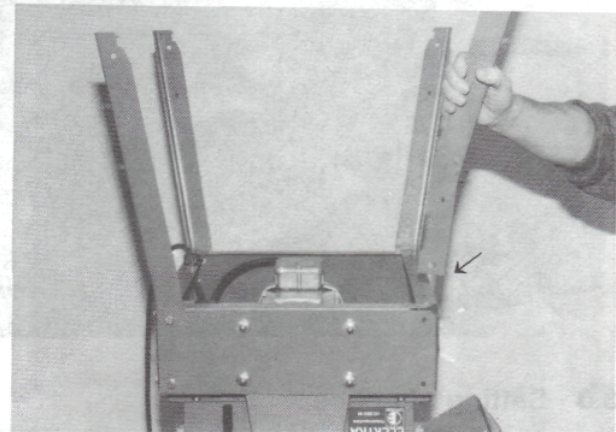
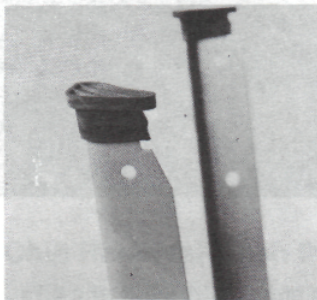

- 2.5 Attach chip ejection hood to extrusion using the 4 sheet metal screws supplied.

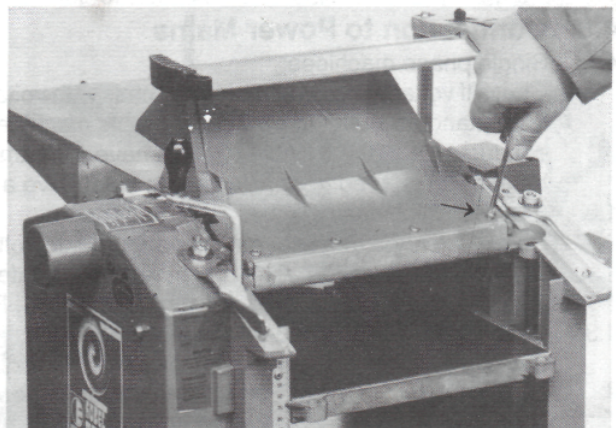

- 2.6 Bolt fence carrier with 2 hex. bolts M8 to the infeed table.



Pull, then lever swings freely

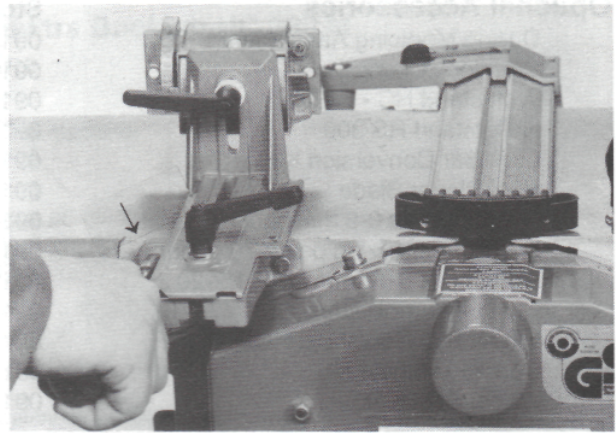

- 2.7 Slide carriage bolts into the fence extrusion and bolt to fence segment, using the two M6 self-locking nuts. Fix cover plate to fence bracket with two cyl. bolts M4x8 and washers A4.2.

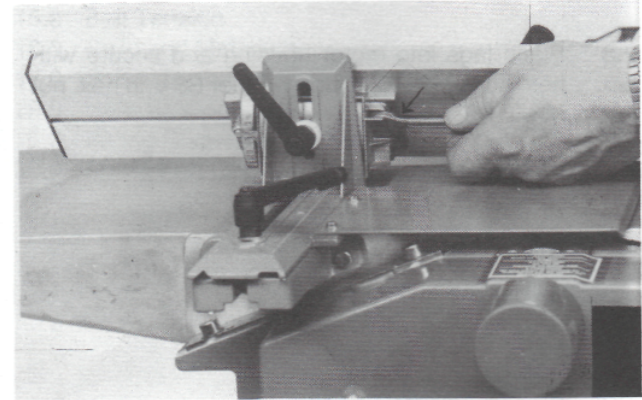
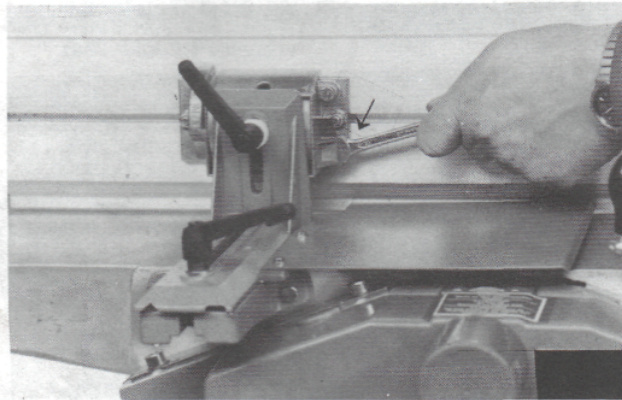
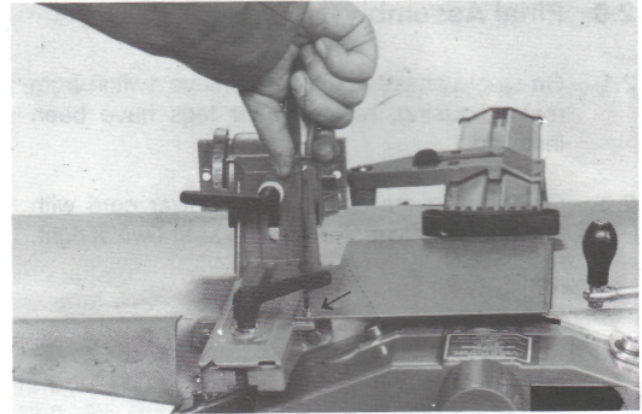
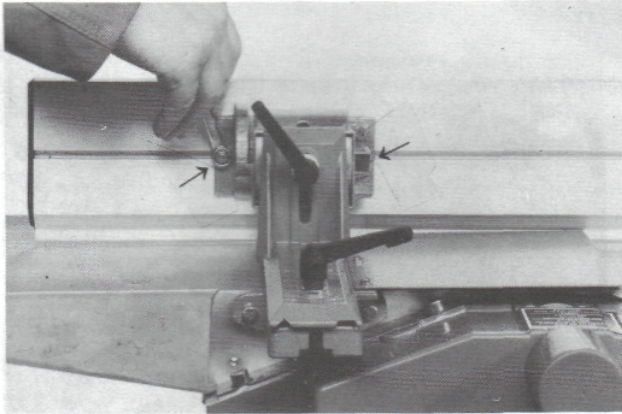

3.0 Setting of Fence

By turning fence setting screws in or out as required, adjust fence segment stops to true 90° and 45°.

4.0 Connection to Power Mains

4.1 Single phase machines:

Check if voltage of power mains matches with voltage stated on the machine's type plate. Fit plug matching your local standard outlet to power cord. This machine must be safety earthed. The yellow/green lead is the earth conductor. A 220/240 V circuit must have a 13 amp fuse, fitted on a 110 V circuit a min. 20 amp time-lag circuit breaker is required. Extension cords must have a min. cross section of 2.5 mm²/12 AWG.

4.2 3-phase machines:

Check if voltage of power mains matches with voltage stated on the machine's type plate. Fit plug of your local standard to power cord. This machine must be safety earthed. The yellow/green lead is the earth conductor. Min. lead cross section required is 1.5 mm²/16 AWG. Protect circuit with 16 amp time-lag fuses.

4.3 Direction of rotation on 3-phase machines:

Switch machine on **briefly** to check cutterblock direction of rotation. If necessary correct by interchanging two phase leads (black or brown). **Do not** interchange the yellow/green **earth lead** with the blue **neutral lead**. If in doubt leave job to a qualified electrician.

5.0 Switch

All switches are equipped with a no-volt release solenoid (magnetic switch). This feature prevents the machine from starting up after a power failure. **A light humming from the switch when machine is switched off, but connected to power mains, is normal and does not represent a fault.**

5.1 -IMPORTANT - WIRING INSTRUCTIONS

Warning: This appliance must be earthed!

For machines with a single phase motor (220-240 volt or 110 volt) the mains lead is to be connected in accordance with the following colour code.

Green and Yellow	-	Earth	⊕
Blue	-	Neutral	
Brown	-	Live	

3-Phase Motors

Machines fitted with 3-phase motors are connected to the mains using a 5-pin industrial appliance-inlet/connector to BS 4343 (IEC 309)

Ensure it is wired and connected only by a qualified electrician.

IF IN DOUBT - CONSULT A QUALIFIED ELECTRICIAN!

6.0 Motor Protection

All switches are equipped with a motor protection relay, which automatically trips when the motor is overloaded. On single-phase machine a small pin is located on the switch housing, which simply needs to be pushed in to reset the motor protection relay. On 3-phase machines the switch needs to be switched off. After the motor protection relay has tripped let motor cool down for at least 10 minutes.

7.0 Chip Removal

Standard delivery with this machine is a suction connector of 100 mm/4" diameter. We recommend to use the Elektra Beckum Dust Collector SPA 1000, which has been designed specifically for use with this planer/thicknesser.

8.0 Chip Removal when Planing

Set thicknessing bed to approx. 2/3 capacity and place suction connector onto it. Raise thicknessing bed to lock suction connector in position. Make sure that the notch on top of the connector locks on the spacer shaft.

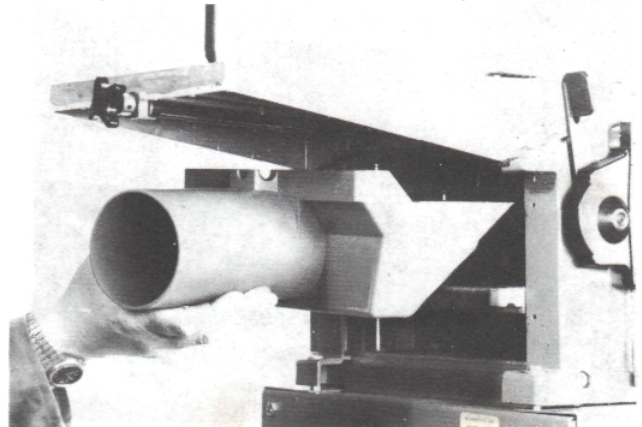
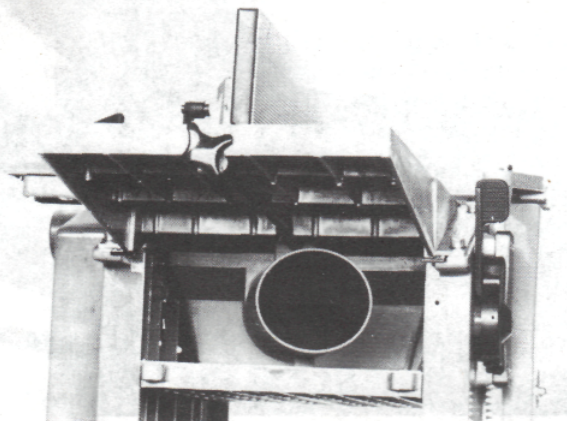

9.0 Chip Removal when Thickening:

9.1 Thickening without dust collector:

Take off outfeed table, slide guard extrusion clear of table and set guard to highest position. Swing chip ejection hood over the cutterblock and secure in place with the lock levers as well as lowering the guard onto it.

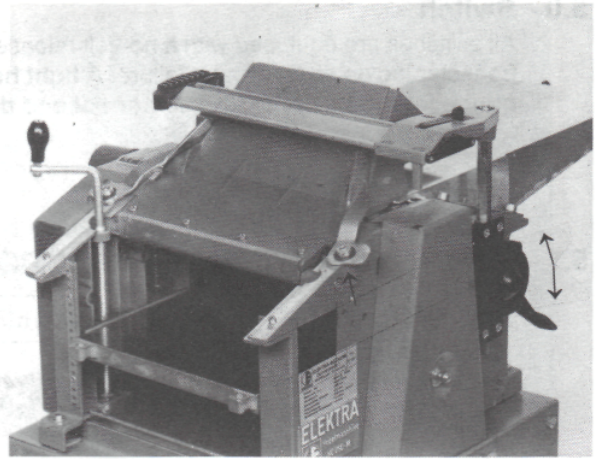

9.2 Thickening with dust collector:

Bring chip ejection hood into position as in 9.1, then place the suction connector onto it. Secure with lock levers and guard.

Caution!

The chip ejection hood is the cutterblock guard when the machine is set up for thickening.

Never operate machine without chip ejection hood in place and properly secured.

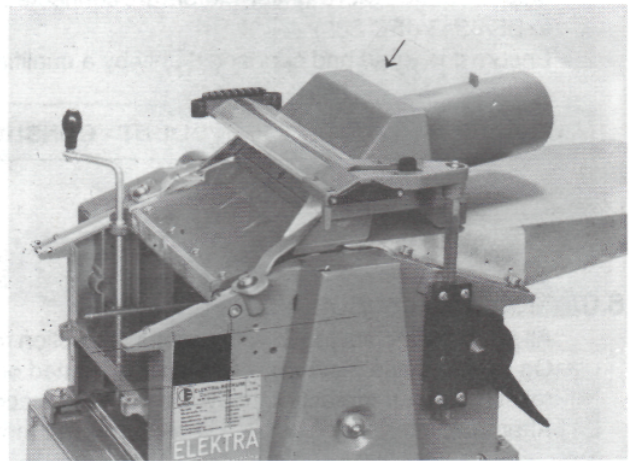

10.0 Setting of VARIO Guard (Standard on HC-M/K/ES, optional on HC-E models)

Height adjustment is made with the lever mounted on the left side of the machine. After lifting the lock lever the blade cover can be slid sideways to set the required stock width for jointing. Push lock lever down to lock guard extrusion in position.

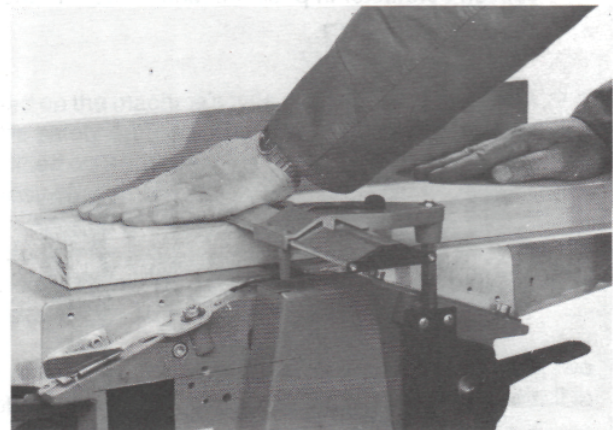
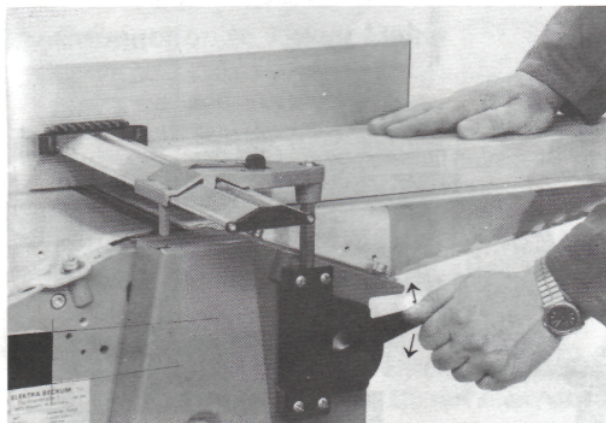

11.0 Planing

Place stock flush onto infeed table, with your left hand set the cutter guard to the required height (stock should just run clear of the guard). Start machine and push stock slowly and steady against the cutter block. Hands slide **over the blade cover**.

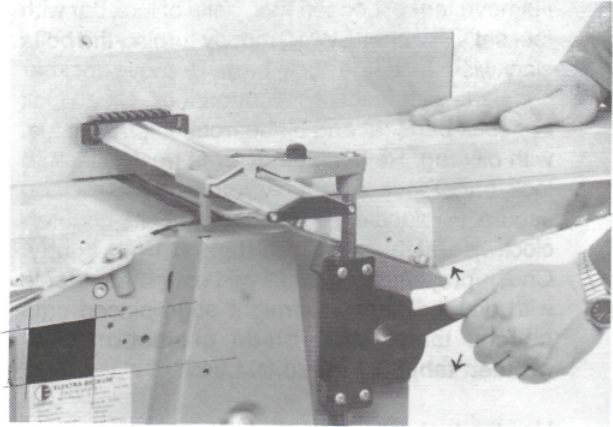
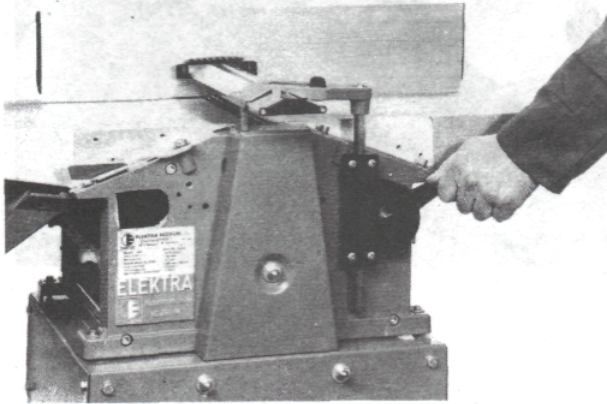

11.1 Jointing

For planing the narrow sides of a workpiece release the blade cover's lock lever and set blade cover to width of stock. The plastic spring on the end of the blade cover should exert a slight pressure against the stock. Lock blade cover in place and start machine. Push stock slowly and steady against the cutter block. Be sure that fence is set at true 90° (or any other angle required) and stock is kept flush against fence.

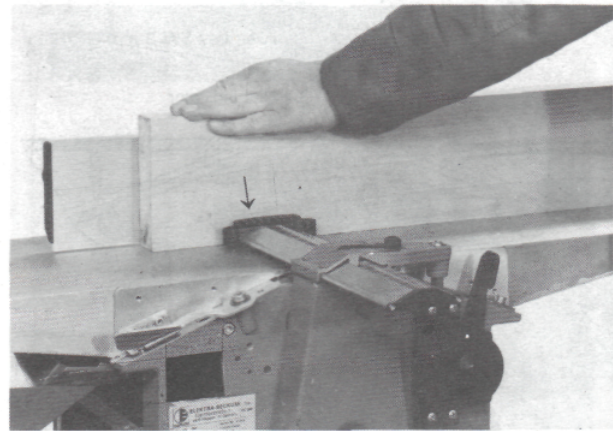
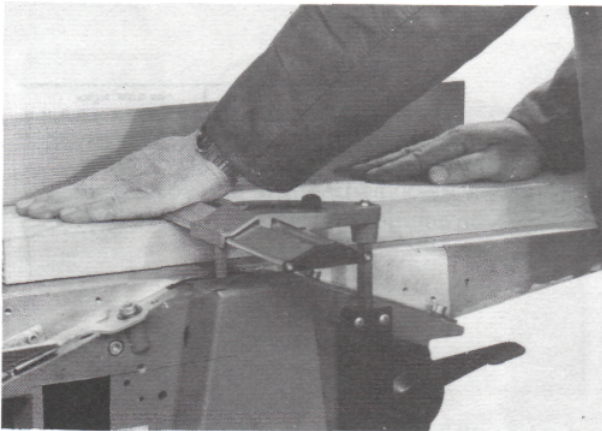

12.0 Thicknessing

Prepare machine for thicknessing as described under para. 9.0. Set thicknessing bed to required thickness of stock (but max. 5 mm more than actual thickness of stock). Start machine and place stock with **planed side facing down** onto thicknessing bed and slowly push forward until feed roller engages. With wedge-shaped stock feed thicker side first. Wet stock can be slightly coated with kerosene to improve sliding capabilities.

For working long stock use of the Elektra Beckum roller stand (stock-no. 091 101 2367) is recommended.



13.0 Replacing/Setting of Disposable Blades

Disconnect machine from power before servicing!

Remove fence. Loosen hex. bolts of lock bar with tool set's spanner SW 10 mm by turning the bolts clockwise (into the lock bar). Remove lockbar complete with blade from cutterblock. Clean lock bar, lock bar seat and blade from chips and dust with oily rag. Reverse blade or fit fresh one onto lock bar. Place assembly into cutterblock and secure in place by turning hex. bolts-counter-clockwise, **at this stage only tighten bolts lightly**. Check projection of blade against outfeed table with dial indicator or straight edge placed onto outfeed table. **Max. blade projection over outfeed table 0.1 mm/0.004 inch.**

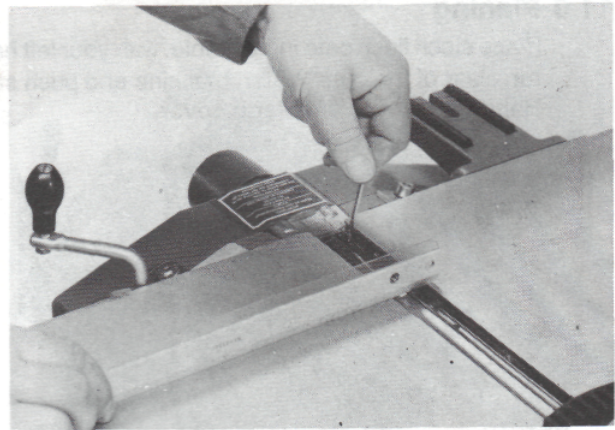

Use the tool set's Allen key SW 3 mm to correct projection by turning the three setting screws of the lock bar in or out, as required. When correct setting is reached fully tighten the hex. bolts. **Start with the centre bolts, then the outer ones.**

Caution!

Do not use spanner SW 10 with longer handle than supplied with machine to prevent excessive torque and possible stripping of threads. For your own safety replace lock bars or bolts with damaged thread at once. Use only genuine Elektra Beckum replacements.

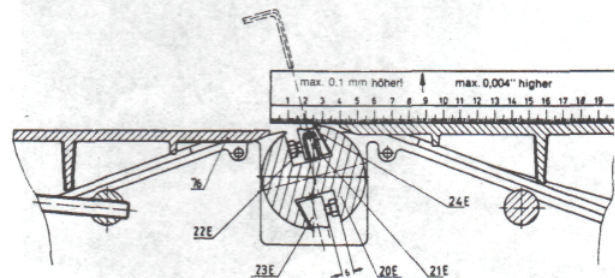
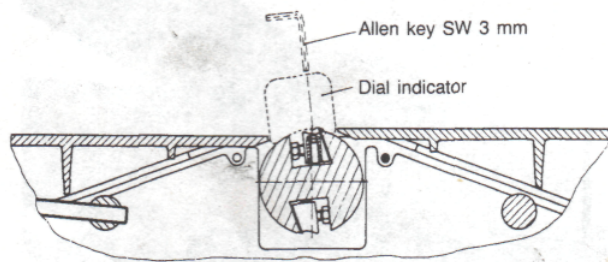

14.0 Fitting/Setting of Resharpenable Blades

For certain markets this machine may be fitted with resharpenable HSS planer blades as standard. If this machine is fitted with disposable planer blades it can easily be modified to accept HSS or TCT resharpenable blades.

- 14.1 To fit resharpenable blades, either HSS or TCT, a Lock Bar Conversion Kit (stock-no. 091 100 1020) is needed in addition to the blades. Remove standard disposable blades as described under para 13.0.
- 14.2 Place resharpenable blade onto lock bar of lock bar conversion kit and place assembly into cutterblock. Tighten hex. bolts lightly.
- 14.3 Check projection of blade against outfeed table with dial indicator or straight edge placed onto outfeed table. **Max. blade projection over outfeed table 0.1 mm/0.004 inch.**
Use Allen key SW 3 mm to set setting screws of lock bar.
- 14.4 When correct setting is achieved fully tighten the hex. bolts **Start with centre bolts, then outer ones.**
Caution! Do not use spanner with longer handle than that supplied with the machine.
- 14.5 Replace lock bar or bolts with stripped thread at once for your own safety. **Use only genuine Elektra Beckum replacements.**

15.0 Belt Tension

After the first 5 hrs of operation check belt tension. Take off cap nut holding the drive belt cover (215). Check tension by pushing against belt, play should be approx. 15 - 20 mm/5/8-2/4 inch).

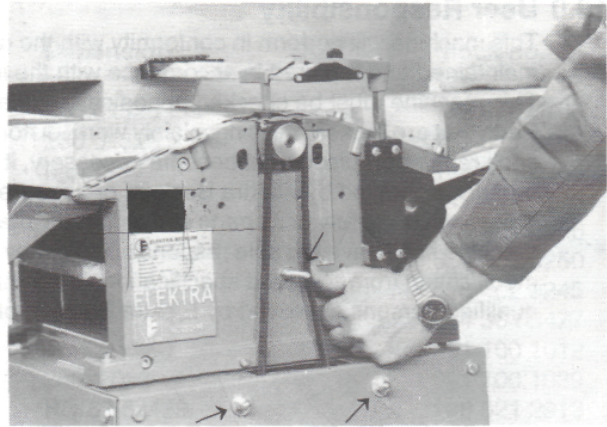

16.0 Care and Maintenance

Regularly clean the thickener drive gear from dust with brush or compressed air. Lubricate all bearing points and chains **regularly with a few drops of motor oil. Keep flat belt free of oil and grease.**

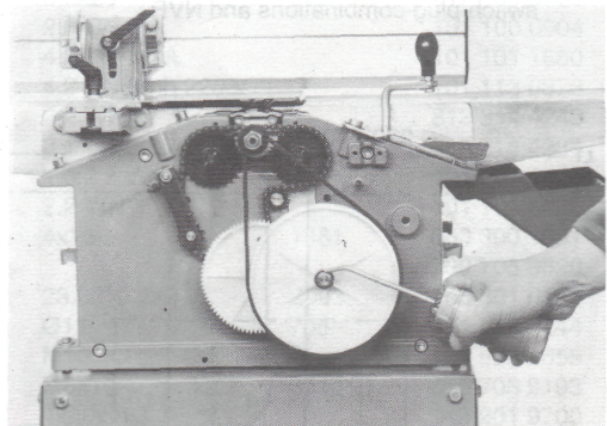

16.1 Regularly clean the thickening bed spindles from chips and dust and lubricate with spray oil (e.g. WD 40) **Do not use regular oil.**

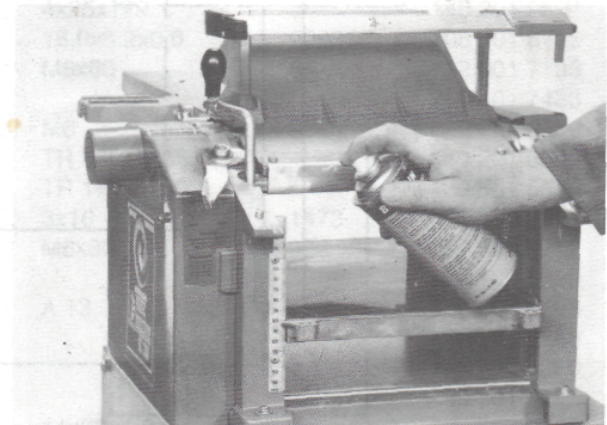

16.2 Keep infeed/outfeed tables and thickening bed free of resin. Clean regularly with kerosene or petrol, then coat with a light film of WAXILIT antiseizing paste to enhance gliding of stock on tables.

17.0 Safety Instructions

- Regularly check that blades and lock bars are locked tight in cutterblock
- Max. allowable blade projection over cutterblock 1.0 mm/0.004 inch + 10 %.
- Never remove any of the machine's safety guards other than for servicing and repair work. Keep guards operational at all times.
- Set and secure safety guards in position before operating machine.
- When operating machine in enclosed spaces connect to a dust collector.
- This machine must be safety earthed. The yellow/green lead is the earth conductor.
- Regularly check anti-kickback fingers for proper operation.
- Always wear eye protection.
- Rebating, tenoning, moulding and recessing may not be undertaken without the use of special guards.
- Never make jointing or planing cut deeper than 3 mm/1/2".

18.0 User Responsibility

This machine will perform in conformity with the description contained in this manual when installed, operated, maintained and repaired in accordance with the instructions provided.

This machine must be checked periodically. Defective equipment (including power cable) should not be used. Parts that are broken, missing, plainly worn, distorted or contaminated, should be replaced immediately. Should such repair or replacement become necessary, it is recommended that such repairs be carried out by qualified persons approved by Elektra Beckum or its representatives.

This machine or any of its parts should not be altered or changed from standard specifications. The user of this machine shall have the sole responsibility for any malfunction which results from improper use or unauthorized modification from standard specification, faulty maintenance, damage or improper repair by anyone other than qualified persons approved by Elektra Beckum or its representatives.

19.0 Wiring Diagrams

19.1 Wiring diagram for motor 220-240 V 50/60 Hz with switch-plug-combinations and NVR

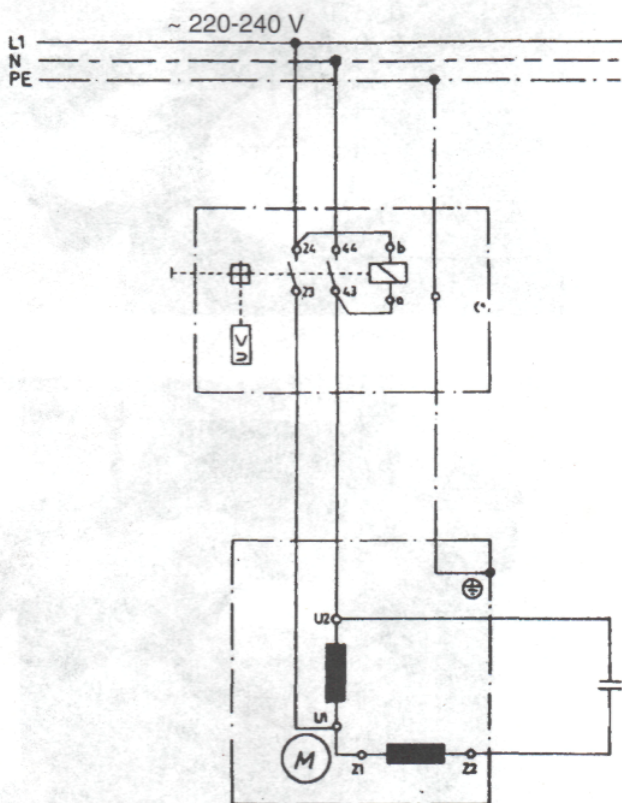

19.2 Circuit diagram for motor 380/415 V 50/60 Hz and 220 V 50/60 Hz switch-plug-combination with motor protection relay and NVR (solenoid 400/230 V)

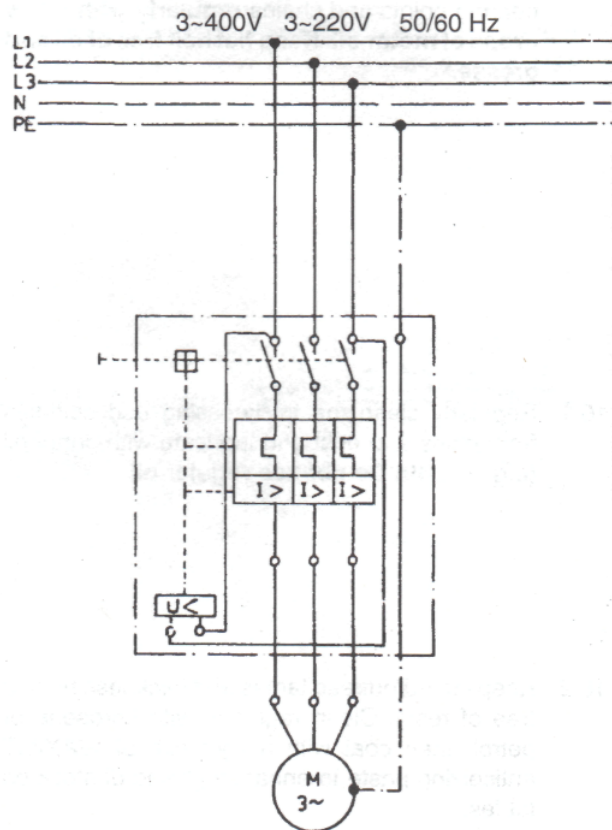

20.0 Spare Part List HC 260

Pos.	Description	Dimension	DIN	Stock-no.
100	Planing bed	286.6x525		139 020 6760
100	Planing bed, hardened	286.6x525		139 011 9468
101	Lock bar screw	M6x11		148 521 0365
102	Lockbar for disposable blades			149 202 0300
	Lockbar for resharpenable blades			149 202 0326
103	Clamping sleeve for lock bar	5x10	1481	650 302 9250
104	Set screw disposable blade	M6x8	916	616 402 9245
	Set screw resharpenable blade	M6		614 304 3477
105	Disposable planer blade	18.6x1x260		091 100 1012
	Resharpenable planer blade HSS	260x20x3		091 100 1039
106	Cutter block HCM/K	RD 62.5x439		138 521 2913
107	Side panel no. 3			139 008 0260
108	Blind rivet	5x16F		662 101 0415
109	Square washer			149 202 0296
110	Hexagon nut	M8	934	620 000 2235
111	Hex. socket head cap screw	M6x25	912	612 100 0766
112	Switch HCM	2.8 DN 5 A		101 100 0904
	Switch HCK	4.2 DN-M7A		101 101 1680
	Switch HCK - B/NL	4.2 DN 3-ph 220 V		101 113 6873
	Switch HCM - AUS	2.2 WN 11 A		813 314 4243
	Switch HCK	3.1 WN 15 A		813 314 4235
	Switch HCM - GB/NZ/DK/CH	1.8/2.2 WN		101 101 1426
	Switch HCM - CDN	2.2 WN		101 101 8536
114	Clamping sleeve	4x16	1481	650 300 1681
116	Star knob			700 706 9620
117	Disk spring	23.0x10.2x0.9	2093	705 301 0100
118	Set collar	Ø11	705	641 014 7244
119	Threaded rod	M10 Ø 60x470		139 520 6555
120	Hex socket head cap screw	M6x16	6912	612 705 9193
121	Spacer strip	4x20x193		149 201 9700
122	Hex. socket head cap screw	M6x12	6912	612 715 1537
123	Hex. socket head cap screw	M8x16	912	612 115 1101
125	Cover rail	4x25x179		149 201 9697
126	Disk spring	16.0x8.2x0.6	2093	705 301 6795
127	Slotted cheese head screw	M6x60	84	612 001 7193
128	PVC crank handle			700 401 7433
129	Hexagon nut	M6	934	620 000 2219
130	Thickneser bed adjusting spindle	TR 14x3x365		149 201 9302
131	Thickneser bed spindle	TR 14x3x229.5		139 501 6578
132	Grooved dowel pin	3x16	1473	650 100 7275
133	Hexagon head screw	M6x80	933	610 300 8717
134	Glide piece HC			139 100 6039
135	Washer	A 13	125	630 001 6705
136	Feed roller, smooth			149 501 9256
137	Spacer shaft w/tapped hole			149 501 9280
138	Feed roller, coarse			149 501 9248
139	Shim ring	14x20x1.0	988	630 600 9832
140	Set screw	M5.5	913	616 115 1139
141	Check nut	TR 14x3		139 501 6616
142	Thickneser bed w/pointer			139 006 7107
143	Spread insert	M8x13		633 001 7420
144	Shim with hole 8.1	22x22		139 000 8895
145	Pressure spring		2076	705 100 5770
146	Washer	A 8.4	125	630 001 6322
147	Hexagon head screw	M8x80	931	610 200 1093
148	Slotted set screw	M8x16		616 000 0358
149	Pan head tapping screw	St 4.8x9.5	7981	617 201 6683
150	Thickneser bed scale	0.6x16x170		114 107 3024
151	Shim ring	8x14x1.0	988	630 601 7266
152	Spindle bush	RD 16x10		139 102 9268
153	Shim with hole 12.1	22x22		139 000 8887
154	Chain sprocket Z=15 T=6	32.4x15		724 601 7276

Pos.	Description	Dimensions	DIN	Stock-no.
155	Roller chain pitch 8 210 links			723 601 1873
156	Drive chain protection plate	2x259x415		139 201 7620
157	Washer	A 6.4	125	630 001 6365
158	Setting bracket, le + ri	2x53x43		139 201 7573
159	Guide rail, left	4x20x193		149 201 9794
160	Grub screw	M6x8	916	616 402 9245
161	Guide rail, right			149 201 9719
162	Chip ejection hood extrusion	258		139 308 6226
163	Pan head tapping screw	St 4.8x13		617 201 5687
164	Recoil lock segment			239 007 3596
165	Recoil lock bar	RD 6x286		139 501 7396
166	Recoil lock bar	RD 10.72x286		139 501 7388
167	Hexagon head screw	M8x80	933	610 303 0259
168	Chip guide plate	2x48x313		139 201 7506
169	Spacer shaft	20x295		149 501 9272
170	Chain tension sprocket Z=15 T=6	RD 32.4x9.5		724 601 7365
171	Nyloc hexagon nut	M6	985	620 200 2291
172	Threaded bolt	M6 8h9 13x20	668	139 501 7418
173	Chain tension plate	2.5x25x76		139 202 8591
174	Chip ejection hood			139 108 5141
175	Hex. socket head cap screw	M8x25		612 100 0820
176	Pan head tapping screw	4.8x16	7981	617 200 1830
177	Hex. socket head cap screw	M8x25	912	612 100 0820
178	Chip ejector hood	ABS		139 108 5133
200	Fence extrusion end cap, right			139 102 8644
201	Fence segment			139 002 8497
202	Glide segment			139 103 0606
203	Hexagon head screw	M8x50	931	610 200 8306
204	Fence extrusion	600		139 300 6850
205	Carriage bolt	M6x20	603	611 000 0608
206	Fence extrusion end cap, left			139 102 8636
207	Guard extrusion			139 306 7280
208	Guard extrusion clamping lever			139 106 7240
209	Cap nut	M8	1587	620 100 2131
210	Guard support			139 006 7239
211	Guard extrusion end cap			139 106 7666
212	Countersunk head tapping screw	St 3.5x13	7982	617 400 1900
213	Side panel lid	2x30x153		139 208 6508
214	Countersunk head tapping screw	St 4.2x13	7982	617 400 1942
215	Drive belt cover HCM/K			139 206 5900
216	Washer	B 8,4	9021	630 500 2486
217	Ratched lever	M8		700 602 8653
218	Plastic washer	Ø 20xØ8x6		139 104 0946
219	Fence carrier HC			139 001 5980
220	Guide segment			139 002 8500
221	Nyloc hexagon head screw	M6x10	933	610 304 1013
222	Washer	A 4.3	125	630 001 6330
223	Raised cheese head screw	4x8	Ähl. 7985	614 302 5088
224	Fence cover plate	1.5x190x190		139 201 7603
225	PVC pressure spring			139 108 2861
226	Guard setting lever			139 106 7259
227	Hex. socket head cap screw	M10x16	6912	612 715 1120
228	Pressure plate			149 202 0245
229	Setting rod, cogged, hexagonal	SW 14x285		149 501 9264
230	Gear cover			139 106 7267
231	Raised countersunk head screw	M6x20	966	613 407 0321
232	Shim ring	10x16x1.0	1093	630 600 2170
233	Lock lever, right			149 201 9425
234	Lock lever, left			149 201 9433
235	J-belt pulley 5Jx42	42x17 M14x1		724 021 2921
236	Bearing cup			139 002 8470
237	O-ring	Ø 40x2.5		763 022 8622
238	Grooved ball bearing 6203 LLU	42x17 M14x1		710 001 7703
239	Guide bar	Ø 10x75		139 501 7884

Pos.	Description	Dimension	DIN	Stock-no.
240	Fence carrier support bracket			239 000 8913
241	Hexagon head screw	M6x20	933	610 300 1135
242	Carriage bolt	M8x40	603	611 001 5990
243	Drive chain sprocket Z=25 T=38	69x16		724 601 7284
244	Clamping sleeve	4x20	1481	650 300 1665
245	Bolt, chain tensioner	Ø16x60.5		139 501 6586
246	Torsion spring			705 100 5753
247	Chain tensioner	4x20x90		149 202 0237
248	Roller chain pitch 6 74 links			723 601 1865
249	Chain sprocket Z=10 T=8	30.5x6.5		724 601 7292
250	Threaded bolt	Ø14x20		139 502 8584
251	Bolt, short	Ø 20x64.5		139 501 6608
252	Bolt, long	Ø 20x89		139 501 6594
253	Star lock w/o cap	Ø 8		701 605 6183
254	Circlip	16x1.0	471	640 000 9900
255	Shim ring	16x22x1.0	988	630 600 9760
256	Flat belt	168x3.2x1.8		091 100 8556
257	Flat belt pulley			724 201 7301
258	Cam wheel Z=25 T=38	69x16		724 701 7342
259	Disk spring	34.0x12.3x1.0	2093	705 301 0096
260	Hexagon nut	1/2"		620 901 7227
261	Drill chuck cover			139 100 7027
262	Thickneser drive gear cover			139 100 5997
300	Spacer bush	Ø 6/Ø 15x18		644 202 5779
301	Washer	B 6.4	9021	630 500 2087
302	Carrying handle			101 121 0127
303	Hexagon head bolt	M 8x16	933	610 300 1178
304	Side panel, neutral			139 206 5829
305	Hexagon head bolt	M 6x40	933	610 300 1151
306	Spring washer	A 8.4	6798	630 400 1745
307	Blind rivet	6x8 F		662 100 9530
308	Front panel, CONDOR switch			139 206 7007
309	Poly-V-belt	5 PJ 864	7867	091 100 7240
310	Hexagon head screw	M 12x1.5 Li.x25	961	610 300 1267
311	J-belt pulley, 50 Hz	5Jx94		724 006 6690
	J-belt pulley, 60 Hz			724 020 7677
312	Feather key	A 6x4x30	6885	672 105 9322
313	Hex. socket head cap screw	M6x16	912	612 102 3081
314	Motor carrier HCM/K			139 206 5837
315	Carriage bolt	M8x16	603	611 000 0632
316	Capacitor	37.5µF/400 V		805 001 1829
	Capacitor	30.0µF/400 V		805 001 1810
317	Capacitor clamp	Ø 45		133 202 5186
318	Pan head tapping screw	3.9x9.5	7981	617 200 1791
319	Motor HCM	2.8kW 380/415 V		801 304 6892
	Motor HCK	4.2 kW 380/415 V		801 308 7769
	Motor HCK	4.2 kW 230 V 3-ph		801 302 6638
	Motor HCM	1.8 kW/220-240 V		801 201 9603
	Motor HCM	2.2 kW 220-240V		801 202 7460
	Motor HCK	3.1 kW 220-240 V		801 208 7757
320	Rear panel			139 206 5799
321	Axle bracket, right			139 207 7215
322	Hexagon head screw	6x16	958/933	610 301 5675
323	Washer	B 6.4	9021	630 500 2087
324	Spring washer	A 6.4	6798	630 408 4047
325	Axle	Ø 20x526		149 501 9345
326	Hexagonal thin nut	M 16	936/439	620 503 2396
327	Wheel	100/35.5		727 002 8750
328	Star lock with cap	Ø 12		701 602 5628
329	Axle bracket, left			139 207 7207
330	Steel tube, handle			201 100 0625
331	Handle PVC			700 802 2431
332	Leg HC			139 202 6530
333	Rubber foot 75 shore			705 701 9365

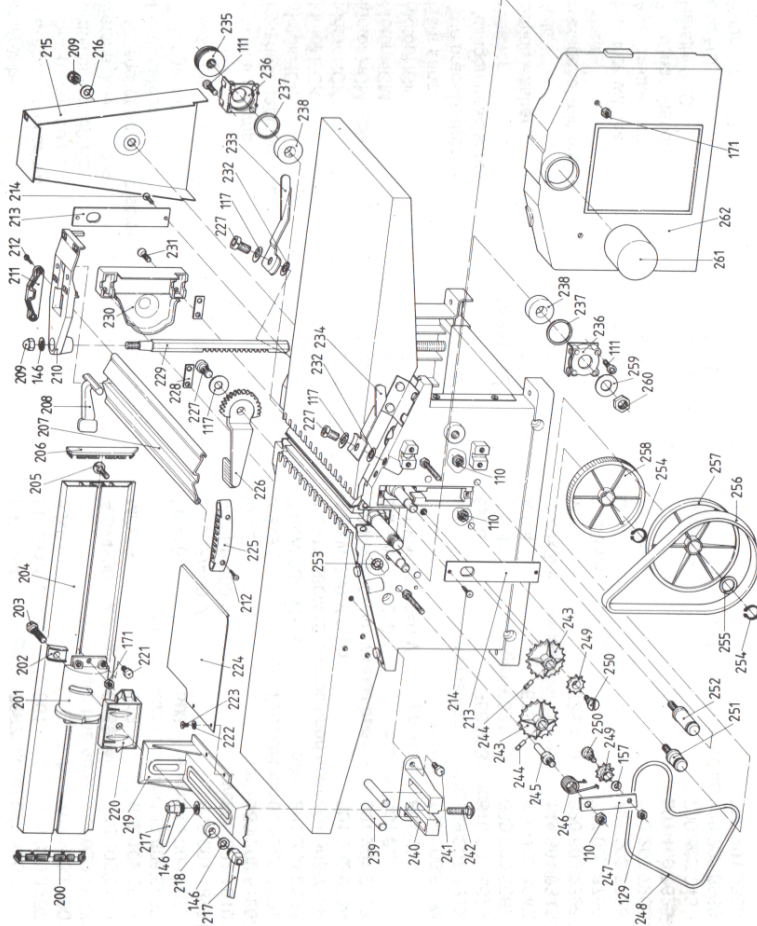
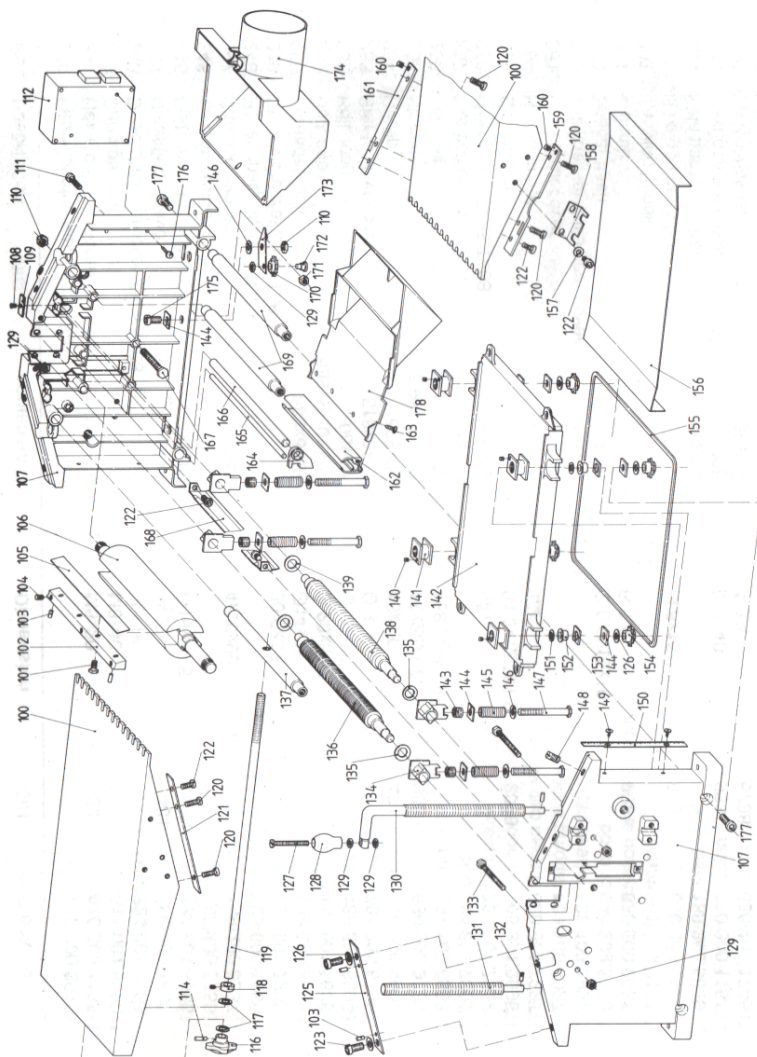

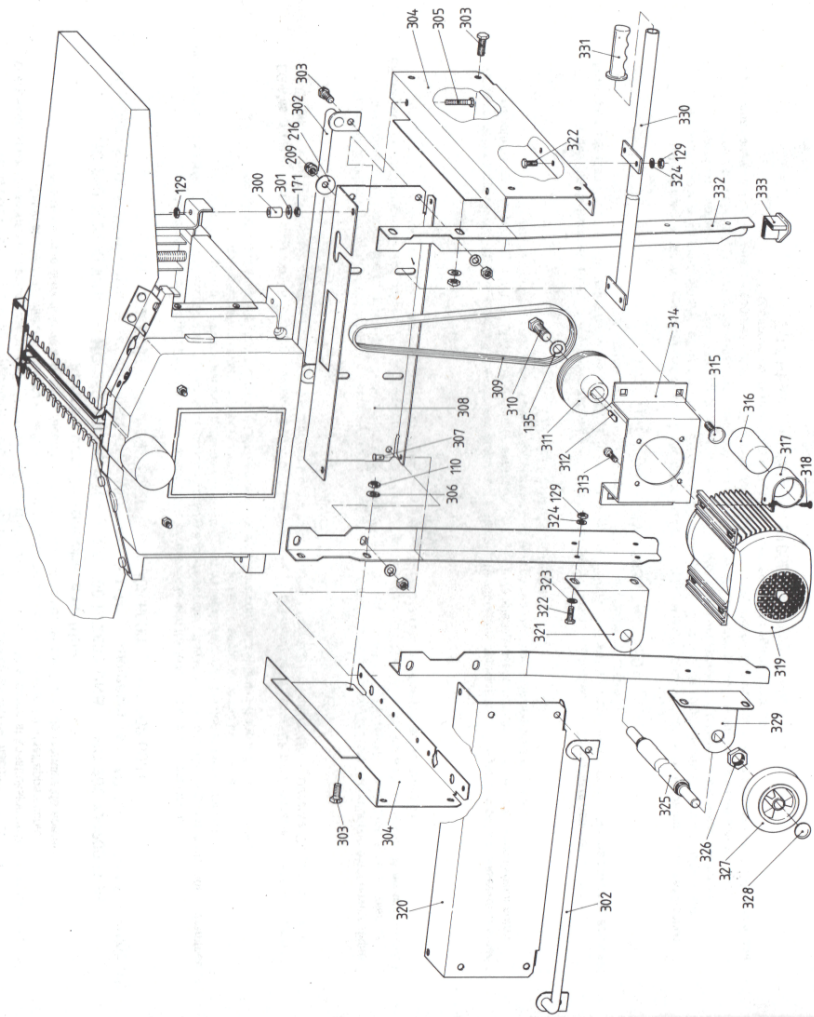

CE

EG-Konformitätserklärung - EC conformity declaration - Déclaration de conformité CEE
EG-erklärung van overeenstemming - EF-overensstemmelsesattest - EG-konformitetsdeklaration
EF-konformitetserklæring - Selvitys ey-standardinmukaisuudesta - Dichiarazione di conformità CE
Declaración de conformidad-UE - Declaração de conformidade CE

Wir erklären, daß die Bauart der Maschine/des Gerätes - We declare that the design of the machine/appliance
Nous certifions que le type de la machine/de l'appareil - Wij verklaren dat de constructie van de machine/het apparaat
Vi erklærer, at konstruktionen af maskinen/apparatet - Härmed försäkras vi att maskin/apparat - Vi erklærer at konstruksjonsmåten til maskin/apparat
Täten selvitätämme, että alla mainittu kone/laite - Dichiariamo che il modello della macchina/dell'apparecchio
Declaramos, que el modelo de la máquina/aparato - Declaramos que o tipo de construção da máquina/do aparelho

Abricht- und Dickenhobelmaschine

HC 260 M/2200 WNB - HC 260 K/3100 WNB - HC 260 M/2800 DNB - HC 260 K/4200 DNB
Art.-Nr. - Stock-no. - N° d' article - art.-nr. - art.-nr. - Art.-nr. - Art.-Nr. - tuotenumero - N° Art. - Art.N° - artigo n°:
011 302 6081 - 011 202 6053 - 011 302 6090 - 011 202 6061

folgenden einschlägigen Bestimmungen entspricht - corresponds with the following relevant regulations
est conforme aux règlements applicables suivants - aan de volgende terzake geldende voorschriften voldoet - opfylder følgende gældende bestemmelser
enligt sitt byggsätt motsvarar följande gällande föreskrifter - oppfyller de følgende gjeldende bestemmelser
vastaa seuraavia asiaa koskevia määräyksiä - corrisponde alle seguenti norme in materia
se ajusta a las siguientes directrices correspondientes - se enquadra com as seguintes disposições pertinentes:

EG-Maschinenrichtlinie - EC machine directive - directive CEE pour les machines - EG-machinerichtlijn - EF maskindirektiv - EG-maskindirektiv
EF maskindirektiv - Koneita koskeva EY-direktiivi - Direttiva CE per macchinari - Directriz de máquinas-UE - Directiva CE para máquinas
89/392/EWG

EG-Richtlinie Elektromagnetische Verträglichkeit - EC-directive electro-magnetic compatibility - directive CEE sur la conformité électromagnétique
EG-richtlijn elektromagnetische compatibiliteit - EF-direktiv vedr. elektromagnetisk fordragelighed - EG-direktiv för elektromagnetisk tolerans
EF-direktiv om elektromagnetisk kompatibilitet - Sähkömagneettista toleransitasoa koskeva EY-direktiivi - Direttiva CE compatibilità elettromagnetica
Directriz-UE Compatibilidad electromagnética - Directiva CE sobre compatibilidade electromagnética
89/336/EWG

Angewendete harmonisierte Normen - Applied harmonized standards - normes harmonisées appliquées - Toegepaste geharmoniseerde normen
Anvendte harmoniserede standarder - Tillämpade nationella direktiv - Anvendte nasjonale normer - Sovelletut kansalliset normit
Norme armonizzate applicate - Normas armonizantes aplicadas - Normas harmonizadas aplicadas:
DIN-EN 294; EN 60204-1

Angewendete nationale Normen - Applied national standards - normes nationales appliquées - Toegepaste nationale normen
Anvendte tyske standarder - Tillämpade nationella direktiv - Anvendte nasjonale normer - Sovelletut kansalliset normit - Norme nazionali applicate
Normas nacionales aplicadas - Normas nacionais aplicadas
VBG 7j; ZH 1/3.8; DIN 45635 Teil 1650

Die Baumusterprüfung wurde von folgender gemeldeter Stelle durchgeführt - The type test was carried out by the following registered location
L'homologation a été effectuée par l'office suivant - De constructiemodel-keuring werd door de volgende officiële instantie uitgevoerd
Typemønstertestprøven er gennemført af følgende registrerede institut - Mønstertestet utførtes på følgende autoriserad institution
Prototypen ble testet av følgende registrerte institusjon - Mallikappaleen tarkastuksen on suorittanut seuraava rekisteröity laitos
L'omologazione è stata effettuata dal seguente ufficio - El ensayo de la muestra constructiva ha sido realizada por la siguiente institución autorizada
A inspeção do modelo de construção foi realizada pela seguinte autoridade:
TÜV-Rheinland, Postfach 910351, D-51101 Köln

Nummer der EG-Baumusterprüfbescheinigung - Number of the EC type test certificate - Numéro d'homologation CEE
Nummer van het EG-constructiemodel-certificaat - EF-typemønstertestprøveattestens nummer - EG-provintygets nummer
Nummeret på EF-prototypetestsertifikatet - EY-mallikappaleetarkastustodistuksen numero - Numero del certificato di omologazione CE
Número de la Certificación-UE de la muestra constructiva - Número do certificado de inspeção CE para o modelo:
9311212

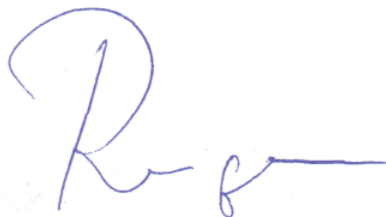

Technischer Leiter - Technical Manager - Le responsable technique - Chef techniek - Teknisk leder - Produktledare
Teknisk leder - Tekninen johtaja - Direttore tecnico - Director técnico - O director técnico